

## OEM Alpha 2: Room Control Unit Radio with Display

The **OEM Alpha 2: System Radio** is the intelligent room-by-room temperature control for the future, ensuring maximum comfort and energy efficiency for surface temperature adjustment.

The wireless control unit of the system is the OEM Alpha 2: Room Control Unit Radio with Display in a modern design. Its comprehensive functionality for the access to all room and system specific parameters and the precise temperature registration allow to establish a perfectly matched room-by-room temperature control system for maximum user comfort. Beyond this it ensures the bidirectional data exchange with the base station Radio for the call of numerous status messages as well as their indication on the large, clearly visible display. Operation is performed via a rotary control with rotary-push action and fine ratchet as well as by the language-neutral indication of the high-quality display which is always well visible.

The OEM Alpha 2: Room Control Unit Radio with Display is available in different variants (with remote sensor, without remote sensor). Already in their standard design, it persuades with a modern appearance. A decorative panel is optionally available, rounding off the elegant appearance. Customer-specific differentiation is always possible.

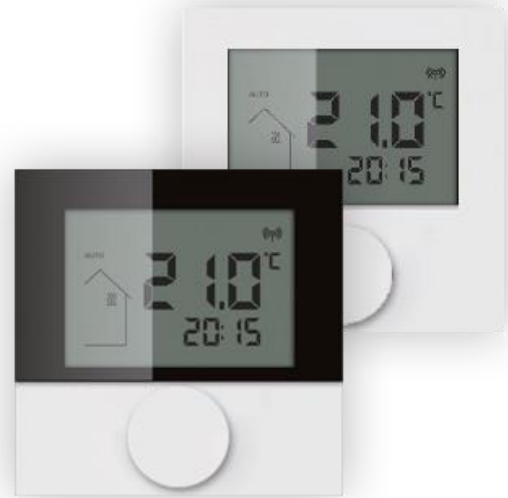

### 1.1 Features

- Flat design and small dimensions (86 mm x 86 mm x 26.5 mm)
- Self-explaining, language-neutral operation and user guidance
- Large, clear LC display (60 mm x 40 mm)
- Continuous indication of room temperature, system time and operating status
- Safe 868 MHz radio technology for optimum positioning without cabling effort
- 3 menu levels (lifestyle functions, parameters and service) for more safety
- Limitation of the room temperature setting range
- Comfortable operation with rotary control (rotary-push action with fine dynamical ratchet)
- Wall and flush-type box installation (Germany & Switzerland)
- Setting range 5... 30 °C
- High-quality OEM design with a multitude of optical differentiation possibilities
- Optionally with remote sensor for floor temperature monitoring
- High-quality decorative panel made of scratch-proof plastics (optional)

The Möhlenhoff OEM product quality ensures easy, intuitive installation, operation and maintenance of the entire system.

### 1.2 Variants

In the respective basic version, the OEM Alpha 2: Room Control Unit Radio with Display will be delivered as neutral devices without logo and in white. The following variants are available in the basic version.

Type designation	Designation	Scope of supply
RDF 64202-00N1	Room Control Unit Radio Display	<ul style="list-style-type: none"> <li>• OEM Alpha 2: Room Control Unit Radio with display without decorative panel</li> <li>• Safety notes in 12 languages*</li> <li>• 2 x AAA battery</li> </ul>
RDF 64212-00N1	Room Control Unit Radio Display with remote sensor	

\* Quick Install Guide in the scope of delivery of the Base Station

**1.3 Optional extensions or differentiations to the basic version****Differentiation possibilities**

Packaging	Individual printing and manufacturing of packaging
Casing	Individual designs, e. g. square, upright, horizontal format, individual colour
Casing printing	Laser marking of the company logo on the casing, and the individual type designation and the device designation
Installation bottom	Colour adaptation, form change
Rotary control	individual colour adaptation
Please contact us if you have further wishes.	

**Extension options**

Decorative panel	High-quality front panel for the Room Control Unit Radio with display	
Instructions, language set 1	Detailed instructions for the room control unit can be attached to the scope of delivery of the base station in the following languages (otherwise these are available for download under <a href="http://www.ezr-home.de">www.ezr-home.de</a> ).	German
		English
		French
		Dutch
		Italian
Instructions, language set 2	Detailed instructions for the room control unit can be attached to the scope of delivery of the base station in the following languages (otherwise these are available for download under <a href="http://www.ezr-home.de">www.ezr-home.de</a> ).	Spanish
		English
		Danish/Norwegian
		Finnish
		Swedish
		Polish
		Russian

## 2 Function

Numerous system functions and parameters can be set via the room control unit for user comfort and for energy optimisation purposes. For this, a tripartite menu structure (lifestyle functions, parameters and service) prevents an accidental change of important settings - even a separate reset of parameter and service set-up to factory settings is possible. Beyond this, the section for installers (Service) is secured against unauthorised access by a PIN code.

### 2.1 Operation

The rotary control allows a comfortable navigation through the intuitive menu structure of the room control unit. Turning to the left or to the right changes between the different functions, pressing the rotary control activates and deactivates these functions and selects them for further parametrisation. The fine ratchet of the rotary control always delivers a feel of high quality experienced by the user during navigation. The following functions/parameters are available in the three menus, among other things.

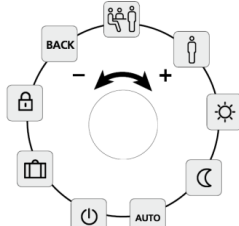
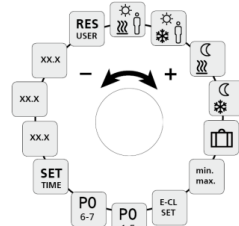
Lifestyle functions	Parameters	Service
 <ul style="list-style-type: none"> <li>• Party function for an hour-wise deactivation of night setback</li> <li>• Possibility of using the weekend heating time programs also on working days (e. g. in case of illness or holidays at home)</li> <li>• Operating modes Day, Night, Automatic</li> <li>• Switching off the room control unit and thus the control operation (antifreeze operation is automatically activated)</li> <li>• Holiday mode for a setback to a defined holiday temperature, enabling energy saving</li> <li>• Child safety lock as a protection against accidental maladjustment and wrong operation</li> </ul>	 <ul style="list-style-type: none"> <li>• Selection of pre-defined lifestyle time programs (can be randomly changed via the on-line parametrisation tool)</li> <li>• separate selection of the target temperature for different programs as e. g. day/night, ECO and holiday</li> <li>• Setting of the floor temperature (only for the floor sensor variant)</li> <li>• Limitation of the adjustable room temperature</li> <li>• Date &amp; time for the overall system</li> <li>• Display of the software versions of room control unit, Base Station and web surface of the Base Station</li> <li>• Reset of user parameters</li> </ul>	<ul style="list-style-type: none"> <li>• Protected against unauthorised access by PIN code</li> <li>• Individual, optimal adjustment of the installation via system parameters as e.g.                             <ul style="list-style-type: none"> <li>- Setting of the applied heating system for each zone (e. g. floor heating, radiator, convector etc.)</li> <li>- Blocking the switching outputs of a zone depending on the activated operating mode (heating/cooling)</li> <li>- Active toggle between heating/cooling</li> <li>- Activation/deactivation of the Smart Start function</li> <li>- Definition of operating locks with/without PIN</li> <li>- Setting the correction of the actual value acquisition</li> <li>- Global change-over of the control direction of the installation (normally open/normally closed)</li> <li>- Setting of the frost protection temperature</li> <li>- Blocking of heating/cooling for individual zones</li> <li>- Toggle between Fahrenheit/Celsius</li> <li>- Setting of numerous pump/boiler parameters</li> </ul> </li> </ul>

### 2.2 Displays

The OEM Alpha 2: Room Control Unit Radio with Display is highlighted by a functional, language-neutral indication. The internationally understandable symbols guarantee intuitive operation.



	Lifestyle functions		Day mode active
	Parameter		Night mode active
	Service		Condensation detected
	Error signal		Cooling mode active
	Child safety lock active		Cooling mode active
	Low battery		Presence active
	Switching off		Party function active
	Radiated power		Minimum floor temperature fallen short of
	Automatic mode active		Holiday function active

### 3 Technical data

Type designations	RDF 64202-00N1	RDF 64212-00N1
Voltage supply	2x LR03/AAA (Micro) alkaline battery	
Battery service life	>2 years	
Reverse polarity protection	Electronically via MOSFET switch	
Remote sensor for floor temperature monitoring (NTC)/external temperature sensor	-	✓
Radio technology	Radio, 868 MHz SRD band	
Degree / class of protection	IP20 / III	
Admissible ambient temperature	0 °C to 50 °C	
Admissible ambient humidity	5 to 80 %, not condensing	
Storage/transport temperature	-10 °C to +50 °C	
Standards and regulations	EN60730-1 / EN60730-2-9 / ElektroG resp. RoHS compliant / DIN EN 300220-1:2013-02 / EN 301489-3:2013-12	
Material	ABS (casing, base, rotary control) / PMMA (disk)	
Colour	RAL9010 (pure white)	
Outer dimensions	86 x 86 x 21.6 mm / 26.5 mm	
Weight	115 g	
Visible display area	40 x 60 mm	
Encoder	30 clicks on 360°	
Target temperature setting range	5 to 30°C	
Target temperature resolution	0.2 K	
Measuring range: actual temperature registration (int. sensor)	0 – 40 °C	
Measuring accuracy of internal NTC	±0.3 K	

#### 3.1 Dimensions

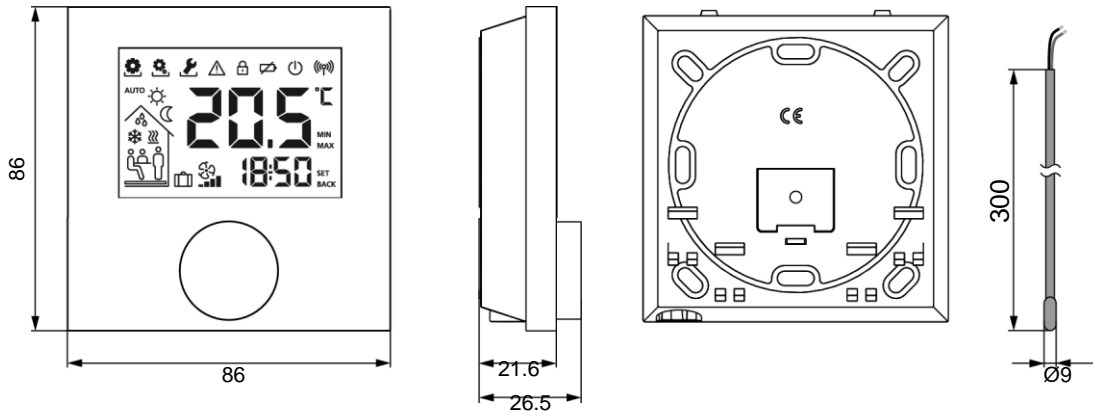

Figure 1: Dimensions OEM Alpha 2: Raumbediengeräte Funk mit Display and external sensor (indications in mm)

#### 3.2 Approvals & certificates

All Möhlenhoff products are extensively tested and certified by independent testing institutes.



## 4 Installation notes

### 4.1 Preconditions

The safe 868 MHz radio technology of the system offers numerous advantages to users and installers as e. g. the optimum positioning of the room control units in the allocated zone without any cabling efforts. This makes annoying caulking and plastering work obsolete. At the same time, all installation conditions can be met without any problems.

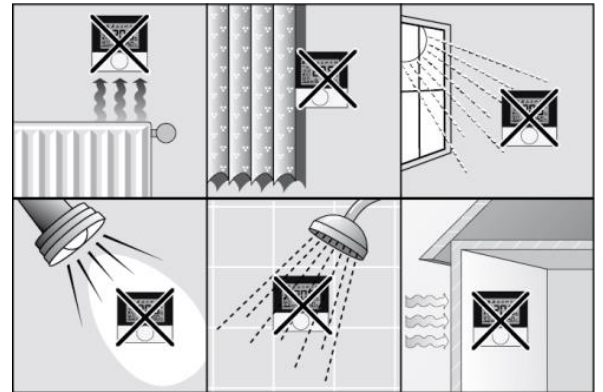
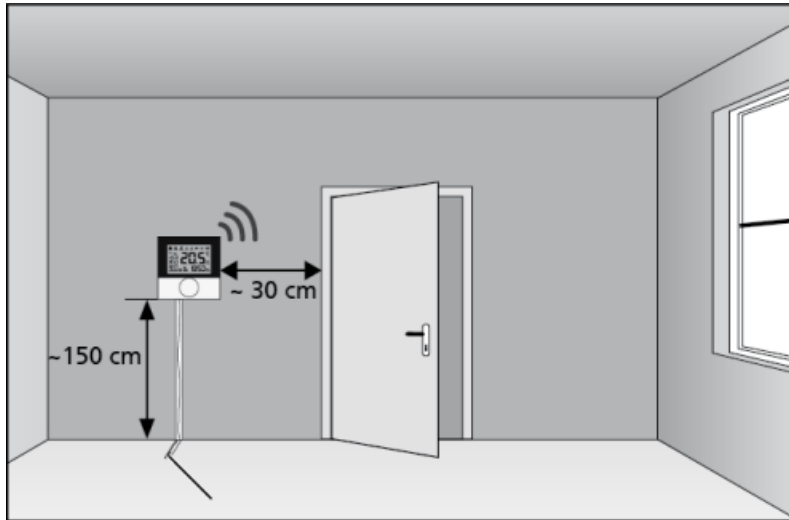

### 4.2 Installation

The room control units are installed comfortably on-surface or in a flush-type box in a few simple steps.

